

BNETA pet

Pet Water Fountain

W4

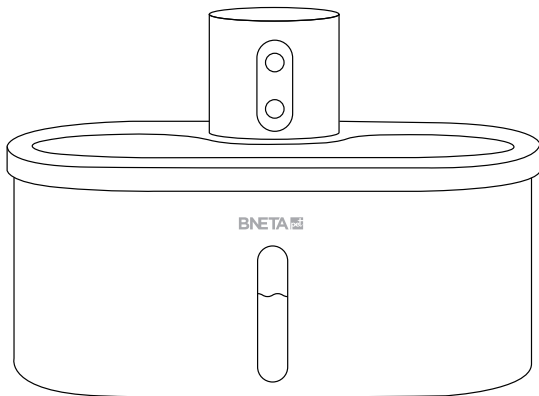

USER MANUAL

BNETA International
sales@bneta.co.za
www.bneta.co.za

SAFETY PRECAUTIONS

Working Conditions

- Place the device horizontally and securely. Do NOT tilt, sway, or turn upside down.
- Exposure to sunlight could damage the internal electronics or cause discoloration. Be sure the device is indoor using only.
- Do not use or store this water fountain in temperatures below 0°C or above 40°C.

Matters Needing Attention

- Adult supervision is required whenever children are near the device. This device is not a toy and we strongly recommend that children do not play with it.
- Any parts of the filter are inedible. Do not use if the filter is broken.
- Do not submerge the main engine in water as this could damage the internal electronics.
- Do not disassemble, maintain, or refit the device, or do anything that will render the warranty void.
- The power cord or plug must not make contact with any liquids to prevent electric shock.
- Ensure charging port is working under a dry conditions.
- Device should be charged by SV/1A or 5V/2A adapter only. Failure to adhere to this could void your warranty.
- Turn off and store the water fountain in a dry place when not in use. Device needs to be charged and maintained after every 6 months in storage.
- Properly dispose of all packing materials immediately after unpacking product, as packaging could cause suffocation or become choking hazard.
- This device is only for providing drinking water for pets. Any other applications are forbidden.
- Make sure to check the level of water regularly to ensure the water fountain is working properly.
- Do not try to repair issues on your own. Please get in touch with your local distributor for further guidance.

COMPONENTS

Main Engine

Drinking Tray

Filter

Water Dispensing Tube

Filter Pack

Water Pump

Water Bowl

Visible Water Level

Type-C USB Charging Cord

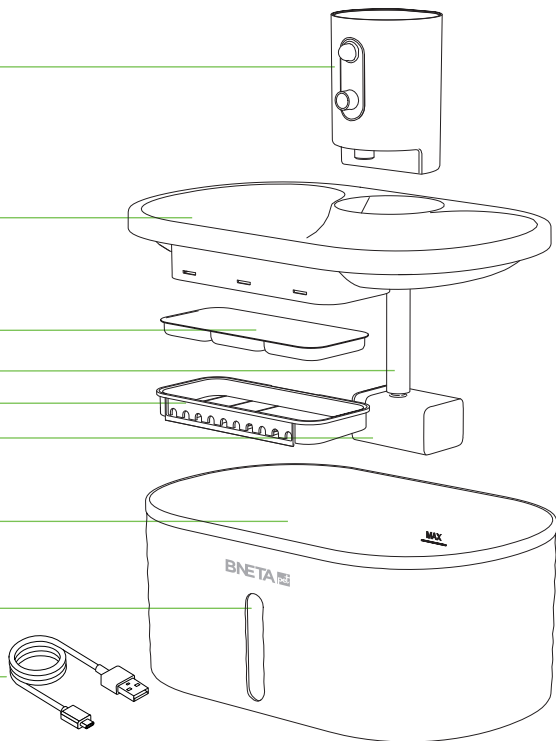

PRODUCT OVERVIEW



Main Engine



Drinking Tray

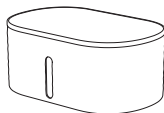

Water Bowl

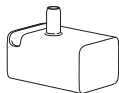

Water Pump



Filter

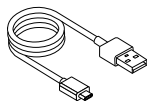

Type-C USB Charging Cord

Operation Interface Overview

Battery Indicator:

Indicator flashes red:

Plug in to charge (low battery warning)

Indicator flashes white:

Device is busy charging
(indicator changes to solid green
when fully charged)

Indicator changes to solid white:

Device working normally and
above low battery.

Regular Flow Mode

(Only works when
device is plugged in)

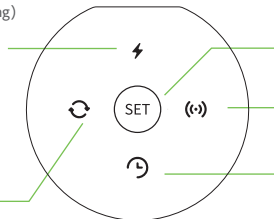

Touch SET Button:

Short Touch: Switch water dispense mode
Long Press for 3 seconds: ON/OFF
water fountain

Induction Mode

Timer Mode

Dispense water for 15 seconds
every 15 minutes

ASSEMBLE & SET UP YOUR WATER FOUNTAIN

1. Soak the filter in water for 5 minutes and rinse it thoroughly.

Notes:

Make sure the filter has been soaked thoroughly to avoid that water flow becomes obstructed. This could cause water overflows.

Do not soak the filter in water bowl to avoid any dust on the surface.

2. Place the filter into the filter pack and fill in the appropriate water into water bowl.
3. Align the Main Engine and downward into the device.

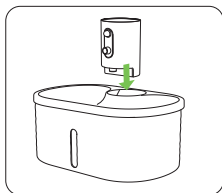
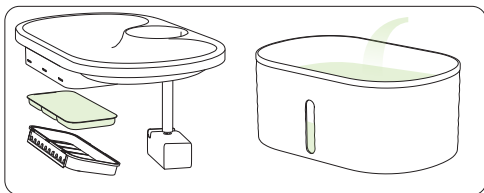
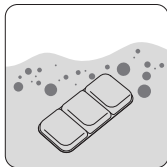

LOW WATER LEVEL WARNING

- White light is on:
Water pump in normal operation
- Red light on:
Water shortage reminder, please add water in time

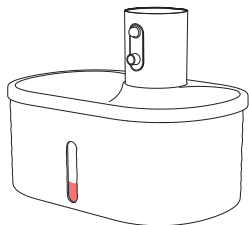

4. Long touch SET button to turn on the water fountain and make sure the device is working under a sufficient power or plug in using.
5. Select water dispense mode you need.

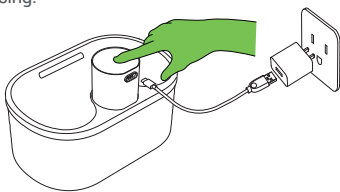

Note:

It's recommended to run the water fountain plugged in and set up to Regular Flow mode. Then switch to other modes when your pets get used to it after a period using the fountain.

CLEANING YOUR WATER FOUNTAIN

Clean the interior of water fountain and drinking tray

1. Take out the main engine.
2. Wash all parts besides main engine. Do not use metal utensils or cleaning aid such as steel balls or abrasive cleaning materials for cleaning to avoid any damage on the product's surface.
3. The drinking tray of the water fountain is NOT dishwasher-safe.

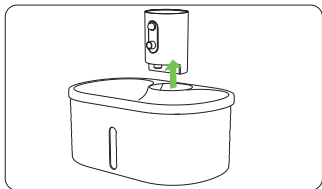

①

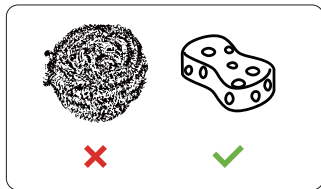

②

PUMP MAINTENANCE

- Remove the filter sponge.
- Remove the water pump cover.
- Remove the stator cover and stator also.
- Clean the stator with water.

GENERAL MAINTENANCE

- Filter and filter sponge are suggested to replace every 2-4 weeks, or 2 weeks with the below conditions:
 - a. High-frequency use
 - b. Multi-pet families
 - c. Water fountain works in regular flow mode
- Water pump and water fountain must be cleaned every week.

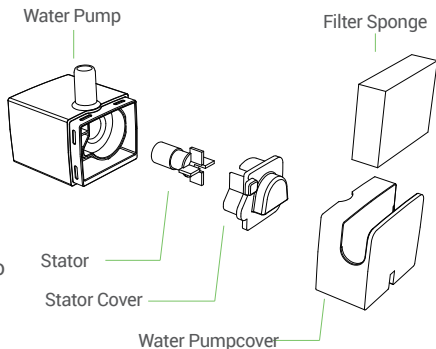

PARAMETERS

Product Name	Lithium Battery Operated Water Fountain
Product Model	W7
Dimensions	260mmx170mmx175mm
Material	ABS
NW	Approx. 0.7KG
Capacity	2.5L
Pets Appliance	Cats and Small Size Dogs
Power	USB 5V1A
Rated Power	0.5W
Battery Capacity	5000mA

TROUBLESHOOTING

ISSUES	SOLUTIONS
Water overflows	Soak the filter in water for 5 minutes and rinse it thoroughly.
	Filter stuck or not use for a long period, please replace or clean it in time.
Water pump stops running	Water in bowl is below the minimum line.
	Clean the water pump, water bowl and water fountain.
	Unplug or low battery: please make sure the main engine is well assembled and plug in the adapter to check the battery power, and charge the battery as needed.
Low water flow	With the first use, or use after a long inactive period, water pump needs venting (normal phenomenon).
	Dirt or fur inside of water pump. Please clean the water pump (see instructions).
	Water in bowl is below the minimum line, please fill the water.
Fouling in water bowl and filter	Please change the water in bowl on a regular basis.
	Please make sure the filter has been soaked and cleaned thoroughly before using.